

SOLAHD

Industrial On-Line UPS - 230 V, 6000 VA

S4KC Series



Instruction Manual

While every precaution has been taken to ensure accuracy and completeness in this manual, Appleton Grp LLC d/b/a Appleton Group assumes no responsibility, and disclaims all liability for damages resulting from use of this information or for any errors or omissions.

The SolaHD and Emerson logos are registered in the U.S. Patent and Trademark Office. All other product or service names are the property of their registered owners.

©2017 Appleton Grp LLC d/b/a Appleton Group. All rights reserved. Specifications are subject to change without notice.

Contents

- Important Safety Precautions** **6**
- Save these Instructions 6
- Glossary of Symbols. 8

- 1.0 Introduction** **9**

- 2.0 System Description** **10**
- 2.1 Surge Protection Devices & EMI/RFI Filters 10
- 2.2 Rectifier/Power Factor Correction Circuit 10
- 2.3 Inverter 10
- 2.4 Battery Charger 11
- 2.5 DC-DC Converter 11
- 2.6 Battery 11
- 2.7 Dynamic Bypass. 11

- 3.0 Major Components** **12**
- 3.1 Main Frame & Electronics 12
- 3.2 Internal Battery Packs 13
- 3.3 Removable Power Distribution Box. 13

- 4.0 Preinstallation** **14**
- 4.1 Unpacking & Inspection 14
- 4.2 What's Included 14

- 5.0 Installation** **15**
- 5.1 Installation Environment. 15
- 5.2 Installing the Main Cabinet. 15
- 5.3 External Battery Cabinet Installation 21

6.0 Configuration Program	25
6.1 Configuration Program Features	25
7.0 Controls & Indicators	26
7.1 On/Alarm Silence/Manual Battery Test Button	26
7.2 Standby/Manual Bypass Button	26
7.4 Battery Level Indicators	27
7.5 UPS Status Indicators	28
8.0 Operation	29
8.1 Startup Checklist for the UPS.	29
8.2 Initial Startup & Electrical Checks.	29
8.3 Manual Battery Test	30
8.4 Put the UPS in Manual Bypass	30
8.5 Shut Down the UPS	30
8.6 Disconnecting Input Power from the UPS.	30
8.7 Maintenance Bypass.	30
8.8 IT Power System Configuration.	31
9.0 Communication	32
9.1 Communication Interface Port	32
9.2 Terminal Block Communications	32
9.3 UPS IntelliSlot Communication Cards.	34
9.4 Remote Emergency Power Off	34
10.0 Maintenance	35
10.1 Replacing the Internal Battery Pack	35
10.2 Battery Charging	36
10.4 Checking UPS Status	37
10.5 Checking UPS Functions	37

11.0 Troubleshooting	38
11.1 UPS Symptoms	38
11.2 Troubleshooting	40
12.0 Specifications	42
12.1 Auto-learning Battery Backup Times.	47
13.0 Warranty & Support	47
13.1 Warranty Information.	47
13.2 Technical Support	47

IMPORTANT SAFETY PRECAUTIONS

SAVE THESE INSTRUCTIONS

This manual contains important safety instructions. Read all safety and operating instructions before operating the Uninterruptible Power System (UPS). Adhere to all warnings on the unit and in this manual. Follow all operating and user instructions. This equipment can be operated by individuals without previous training.

This product is designed for data processing equipment; commercial/industrial use only. It is not intended for use with life support or other designated “critical” devices. Maximum load must not exceed that shown on the UPS rating label. If uncertain about the application, consult your dealer or local SolaHD representative.

This UPS is designed for use on a properly grounded (earthed) 220–240 VAC; 50 or 60 Hz supply. Installation must be performed by qualified personnel. A qualified electrician must review and approve customer supplied wiring, circuit breakers, intended loads and verify correct input, output, and earth connections to ensure compliance with technical standards and local codes of practice. Installation instructions and “for use by qualified personnel only” warning notices are in this manual.

WARNING

Although the UPS has been designed and manufactured to ensure personal safety, improper use can result in electrical shock or fire. To ensure safety, observe the following precautions:

- Turn off and unplug the UPS before cleaning it.
- Clean the UPS with a soft, dry cloth. Do not use liquid or aerosol cleaners.
- Never block or insert any objects into the ventilation holes or other openings of the UPS.
- Do not place the UPS power cord where it might be damaged.

Operate the UPS in an indoor environment only, in an ambient temperature range of 0°C to +40°C (+32°F to +104°F).

Install the UPS in a clean environment, free from moisture, flammable liquids, gases, and corrosive substances.

This UPS contains no user-serviceable parts, except for the internal battery pack. The UPS On/Off buttons do not electrically isolate internal parts. Under no circumstances should you attempt to gain access internally due to the risk of electric shock or burn.

Do not continue to use the UPS if the front panel indicators are not in accordance with these operating instructions or the UPS performance alters in use. Refer all faults to your SolaHD representative.

DO NOT CONNECT equipment that could overload the UPS or demand DC current from the UPS, such as: electric drills, vacuum cleaners, laser printers, hair dryers, or any appliance using half-wave rectification.

Storing magnetic media on top of the UPS may result in data loss or corruption.

NOTICE: If this UPS is supplied from an “IT” electrical power system, the jumper on the rear panel must be disconnected. See “8.8 IT Power System Configuration” for details. When connecting to an “IT” system, the installer must provide a 2-pole upstream circuit breaker. Refer to all local and national codes when installing the upstream breaker.

Battery Safety Notes

⚠ CAUTION

Do not dispose of batteries in a fire; they may explode. Dispose of used batteries according to local regulations.

Do not open or mutilate the batteries. Released electrolyte is toxic and harmful to skin and eyes. If electrolyte comes in contact with the skin, wash the affected area immediately and get medical attention.

⚠ CAUTION

A battery can present a risk of electrical shock and high short-circuit current. Servicing of batteries should be performed or supervised by personnel knowledgeable of batteries and the required precautions.

The following precautions should be observed when working with batteries:

- Remove watches, rings, and other metal objects.
- Use tools with insulated handles.
- Wear rubber gloves, boots, and safety glasses.
- Do not lay tools or metal parts on top of batteries.
- If the battery pack is damaged in any way or shows signs of leakage, please contact your SolaHD representative immediately.
- Disconnect charging source prior to connecting or disconnecting battery terminals.
- Determine if the battery is inadvertently grounded. If it is inadvertently grounded, remove the source from the ground. Contact with any part of a grounded battery can result in electrical shock. The likelihood of such shock can be reduced if grounds are removed during installation and maintenance (applicable to a UPS and a remote battery supply not having a grounded supply circuit).

Electromagnetic Compatibility

The S4K5U6K5C complies with the limits of Category C2, pursuant to IEC/EN/AS 62040-2. Operation is subject to the following conditions: (1) The output cables shall be no longer than 10 m (32 ft.). (2) This device must not cause harmful interference. (3) This device must accept any interference received, including interference that may cause undesired operation. Operating this device in a residential area is likely to cause harmful interference that users must correct at their own expense.

The S4K5U6K5C complies with the requirements of EMC Directive 2004/108/EC and the published technical standards. Continued compliance requires installation in accordance with these instructions and use of accessories approved by SolaHD.

Information for the Protection of the Environment







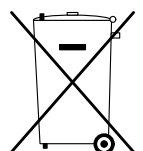



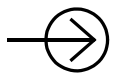

UPS Servicing: The UPS makes use of components dangerous for the environment (e.g. batteries, electronic cards, and electronic components). The discarded components must be taken to a specialized collection and disposal center.

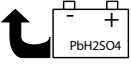
Notice to European Union Customers—Disposal of Old Appliances: This product has been supplied from an environmentally aware manufacturer that complies with the Waste Electrical and Electronic Equipment (WEEE) Directive 2002/96/CE.

The crossed-out-wheellie-bin symbol (at right) is placed on this product to encourage you to recycle whenever possible. Please be environmentally responsible and recycle this product through your recycling facility after the product's end of life. Do not dispose of this product as unsorted municipal waste. Follow local municipal waste ordinances for proper disposal provisions to reduce the environmental impact of Waste Electrical and Electronic Equipment (WEEE).



Glossary of Symbols

	Risk of electrical shock
	Indicates caution followed by important instructions
	AC input
	AC output
	Requests the user to consult the manual
	Indicates the unit contains a valve-regulated lead acid battery
	Recycle
	DC voltage
	Equipment grounding conductor
	Bonded to ground
	AC voltage
	ON/Alarm Silence/Battery Test
	OFF/Bypass
	WEEE

1.0 Introduction

Congratulations on your choice of the SolaHD S4K5U6K5C Uninterruptible Power System (UPS).

The S4K5U6K5C is a compact, on-line Uninterruptible Power System (UPS) which continuously conditions and regulates its output voltage, whether mains power is present or not. It is designed to supply microcomputers and other sensitive equipment with clean sine wave power.

The S4K5U6K5C features a light-emitting diode (LED) display to indicate both load percentage and battery capacity. It also provides self-diagnostic tests, a combination ON/Alarm Silence/Manual Battery Test button, and a Standby/Manual Bypass button.

The S4K5U6K5C has an IntelliSlot® port for communication between the UPS and a network server or other computer system. This port provides detailed operating information including voltages, currents, and alarm status to the host system when used in conjunction with MultiLink™. MultiLink can also remotely control UPS operation.

2.0 System Description

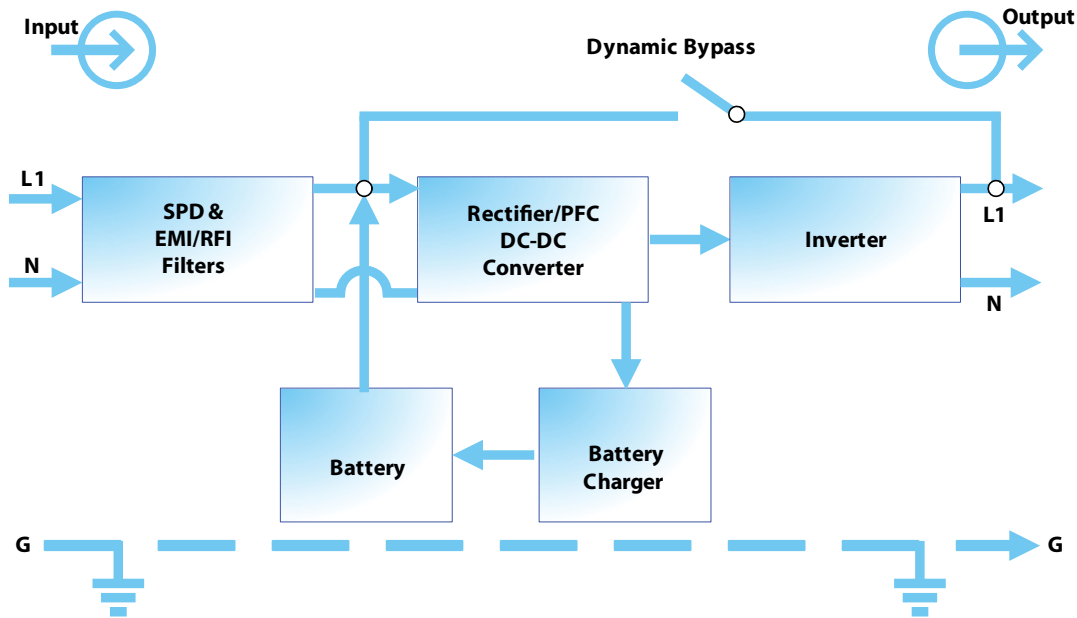

Figure 1: Operating principle diagram

2.1 Surge Protection Devices (SPD) & EMI/RFI Filters

These UPS components provide surge protection and filter both electromagnetic interference (EMI) and radio frequency interference (RFI). They minimize any surges or interference present in the mains line and keep the sensitive equipment protected.

2.2 Rectifier/Power Factor Correction (PFC) Circuit

In normal operation, the rectifier/power factor correction (PFC) circuit converts mains AC power to regulated DC power for use by the inverter while ensuring that the wave shape of the input current used by the UPS is near ideal. Extracting this sine wave input current achieves two objectives:

- The mains power is used as efficiently as possible by the UPS.
- The amount of distortion reflected on the mains is reduced.

This results in cleaner power being available to other devices in the building which are not protected by the UPS.

2.3 Inverter

In normal operation, the inverter utilizes the DC output of the power factor correction circuit and inverts it into precise, regulated sine wave AC power. Upon a mains power failure, the inverter receives its required energy from the battery through the DC-DC converter. In both modes of operation, the UPS inverter is on-line and continuously generating clean, precise, regulated AC output power.

2.4 Battery Charger

The battery charger utilizes energy from the mains power and precisely regulates it to continuously float charge the batteries. The batteries are being charged whenever the UPS is connected to mains power.

2.5 DC-DC Converter

The DC-DC converter utilizes energy from the battery system and raises the DC voltage to the optimum operating voltage for the inverter. This allows the inverter to operate continuously at its optimum efficiency and voltage, thus increasing reliability.

2.6 Battery

The UPS utilizes valve-regulated, non-spillable, lead acid batteries. To maintain battery design life, operate the UPS in an ambient temperature of -15°C to +25°C (+59°F to +77°F). Optional external battery cabinets are available to extend battery backup times. For backup times, see Table 11.

2.7 Dynamic Bypass

The UPS provides an alternate path for mains power to the connected load in the unlikely event of a UPS malfunction. Should the UPS have an overload, overtemperature, or any other UPS failure condition, the UPS automatically transfers the connected load to bypass. Bypass operation is indicated by an audible alarm and an illuminated amber Bypass LED. (Other LEDs may be illuminated to indicate the diagnosed problem.) To manually transfer the connected load from the inverter to bypass, press the Standby/Manual Bypass button once and hold it for about 2 seconds.

NOTE: The bypass power path does NOT protect the connected equipment from disturbances in the mains supply.

3.0 Major Components

The S4K5U6K5C is composed of three major assemblies to provide easier handling, installation, and versatility.

3.1 Main Frame & Electronics

The cabinet is shipped with internal batteries installed and a basic hardwire distribution box attached.

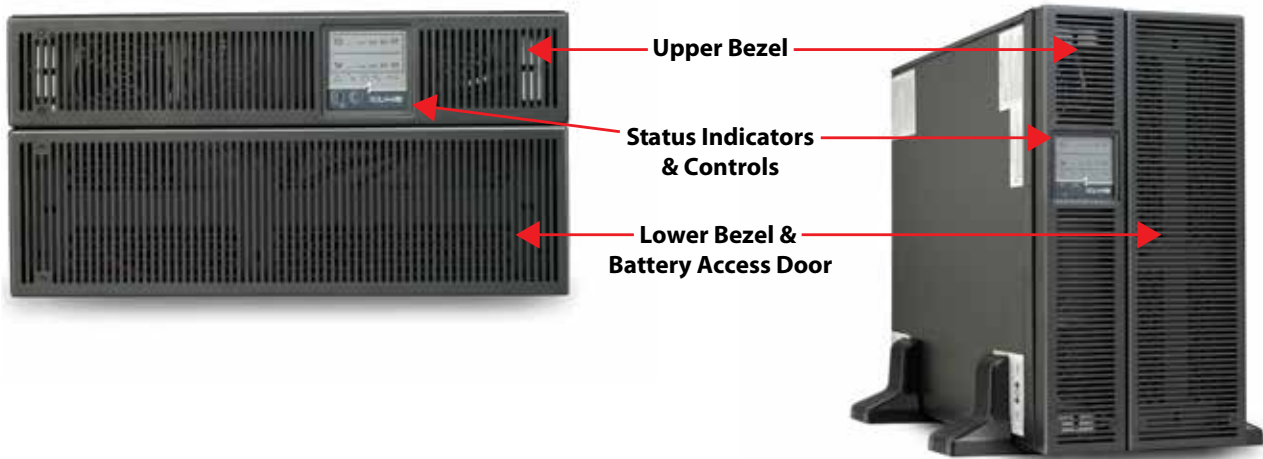

Figure 2: Front view—rack-mount and tower configurations

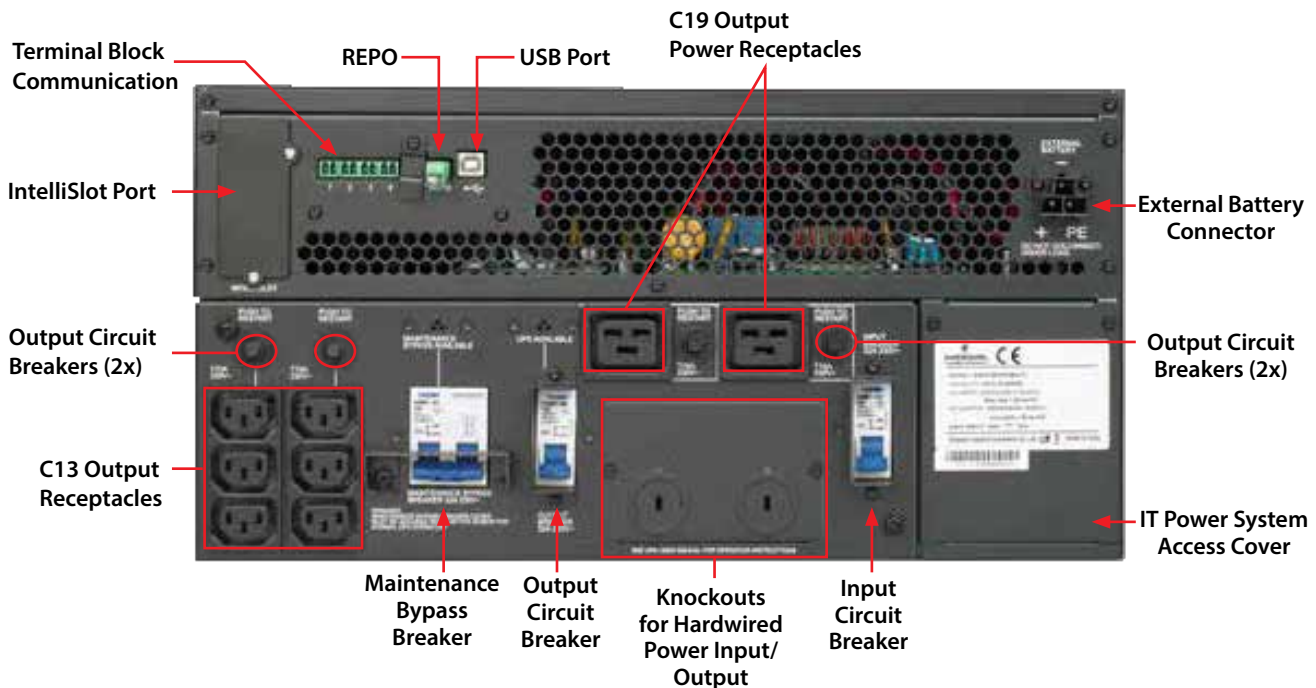

Figure 3: Rear view

3.2 Internal Battery Packs

The UPS has two internal battery packs behind a battery access door on the front of the unit. Each internal battery pack is fitted with a connector to link to the UPS.

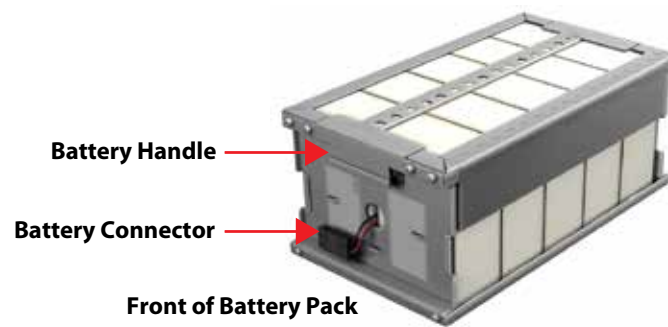

Figure 4: Internal battery pack features

3.3 Removable Power Distribution Box

The UPS is shipped with a power distribution box installed. This box contains the UPS input circuit breaker.

NOTE: Hardwire and hardwire/receptacle boxes that include a manual bypass switch permit AC power to continue to flow from the mains input to the load while the box is removed from the UPS. For details, refer to "5.4 Connect Input/Output Power".



Figure 5: Power distribution box

4.0 Preinstallation

4.1 Unpacking & Inspection

Unpack the UPS and conduct the following checks:

- Inspect the UPS for shipping damage. If any shipping damage is found, report it to the carrier and your local dealer or SolaHD representative immediately.
- Check the accessories against the delivery list. If there are any discrepancies, contact your local dealer or SolaHD representative immediately.

4.2 What's Included

The S4K5U6K5C is shipped with the following items:

- Compact disk with: MultiLink, Configuration program, and User manual (electronic version)
- One USB cable, 2 m (6-1/2 ft.) long
- Mounting hardware, including screws and handles
- Power distribution box (installed on UPS)
- Terminal block communication terminals
- One support base set
- Warnings, safety instructions booklet, and WEEE recycling sheet (ISO 14001 compliance)

The S4K5U6K5C external battery cabinet is shipped with the following items:

- One battery cabinet
- Two spacers (for tower configuration)
- One DC power cable

5.0 Installation

Do NOT attempt to start the UPS, turn on any circuit breaker, or energize the input power until instructed to do so in “8.2 Initial Startup & Electrical Checks”.

⚠ CAUTION

The UPS is heavy (see “12.0 Specifications”). Take proper precautions when lifting or moving the unit.

5.1 Installation Environment

Install the UPS indoors in a controlled environment, where it cannot be accidentally turned off.

Place the UPS in an area of unrestricted airflow around the unit.

The installation location must be free of water, flammable liquids, gases, corrosives, and conductive contaminants. Avoid direct sunlight.

Maintain a minimum clearance of 100 mm (4 in.) in the front and rear of the UPS. Do not obstruct the air inlets on the front panel and rear panel of the UPS. Blocking the air inlets reduces ventilation and heat dissipation, shortening the service life of the unit.

Maintain an ambient temperature range of 0°C to +40°C (+32°F to +104°F).

NOTE: UPS operation in sustained temperatures outside the range of -15°C to +25°C (+59°F to +77°F) reduces battery life.

5.2 Installing the Main Cabinet

The UPS may be installed as a tower configuration or in a rack, depending on available space and use considerations. Determine the type of installation and follow the appropriate instructions in either “5.2.1 Tower UPS Installation” or “5.2.2 Rack-Mount UPS Installation”.

5.2.1 Tower UPS Installation

To install the UPS as a tower:

1. Take out the support bases from the accessories bag (see Figure 6).

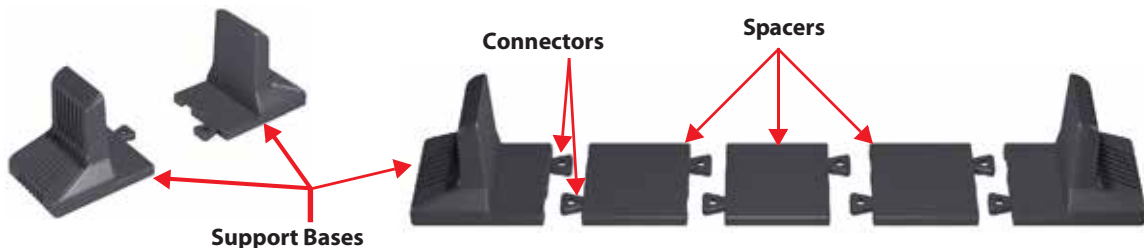

Figure 6: Support bases

2. If optional external battery cabinets will be connected to the UPS, take out the spacers shipped with the battery cabinet.
3. Connect the spacers and the support bases as shown in Figure 6. Each UPS needs two assembled support bases, one in the front and one in the rear.

4. Adjust the direction of the operation and display panel on the UPS.
 - a. Remove the front metal bezel covers as shown in Figure 7.

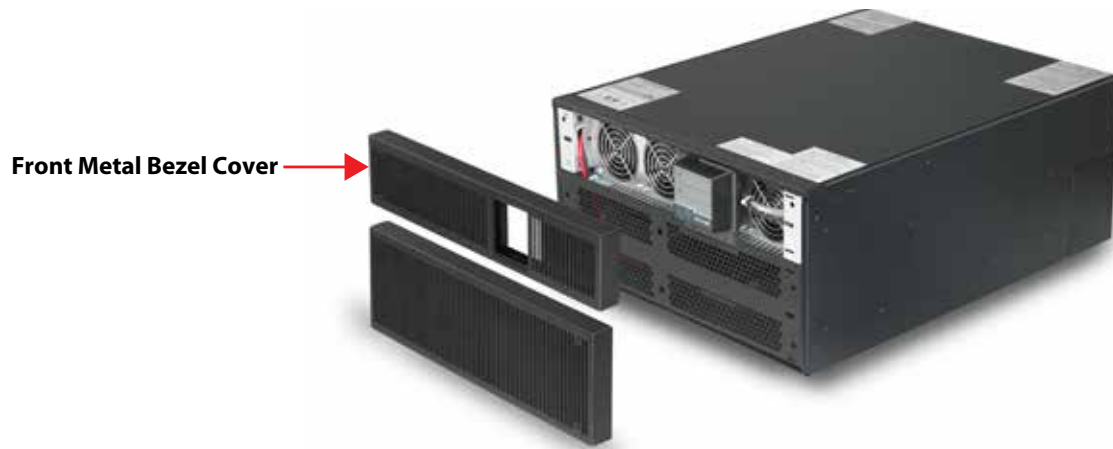

Figure 7: Remove the front metal bezel covers

- b. Using the finger grips on the operation and display panel, gently pull and rotate 90 degrees clockwise and snap it back into position (see Figure 8).



Figure 8: Rotate the operation and display panel

- c. Replace the front metal bezel covers on the UPS.
5. Place the UPS and any battery cabinets on the support bases. Each UPS requires two support assemblies as shown in Figure 2.

5.2.2 Rack-Mount UPS Installation

When using the UPS in a rack-mount configuration, it must be supported by a slide kit, fixed rails, or a shelf.

When using the optional Adjustable Rack-Mount Kit, you will use the instructions below. The figures accompanying “5.2.3 Installing the Adjustable Rack-Mount Kit” show the positioning of the rack-mounting brackets. SolaHD recommends taking the internal batteries out of the UPS during rack installation. This will make the UPS cabinet lighter and easier to handle.

⚠ CAUTION

The UPS is heavy (see “12.0 Specifications”). The UPS must be installed as close to the bottom of the rack as possible. If placed too high, it can make the rack top-heavy and prone to tipping over.

5.2.3 Installing the Adjustable Rack-Mount Kit (Sold Separately)

This kit contains parts needed to mount the UPS and the external battery cabinets into EIA310-D standard four-post racks that are 457–813 mm (18–32 in.) deep. The weight limit per pair of adjustable rack-mounting brackets is 91 kg (200 lb.).

Parts included:

- Two rear bracket members, two front bracket members, two inner bracket members
- Sixteen M4 machine screws, eight M4 locking hex nuts
- Eight M5 machine screws

Tools needed for installation:

- Phillips screwdriver
- 7 mm wrench

The adjustable rack-mounting brackets (Part#: SRS18-32) feature retaining latches to prevent users from inadvertently sliding the UPS or battery cabinet out of the rack.

To install the rack-mount brackets:

1. Unpack two rack-mounting bracket assemblies and mounting hardware from this kit. Bracket assemblies are interchangeable between left-hand or right-hand.

Remove the inner member from each bracket assembly as shown in Figure 9 by extending it to its outer-most position, depressing the retaining latch and then pulling the inner member out of the bracket assembly.

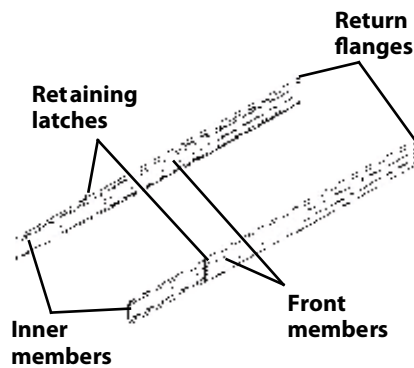

Figure 9: Removing the inner member from each bracket assembly

- Determine the height position inside the rack enclosure where you want to mount the UPS or battery cabinet.

⚠ CAUTION

Reduce the risk of tipping the rack enclosure by placing the UPS or battery cabinet in the lowest possible rack position.

- Install the rear member of each bracket assembly into the rack enclosure with two M5 screws provided in this kit (see Figure 10). The return flanges on the bracket assembly fit to the inside of the rack mounting rails. Insert screws loosely (finger-tight) into the top and bottom holes of the return flange on the rear member.

Extend the bracket assembly by sliding the front member forward until it touches the front rack mounting rail. Insert two M5 screws loosely (finger-tight) into the top and bottom holes of the return flange on each front member. Make sure that the bracket assemblies are at the same mounting height on all four rack mounting rails.

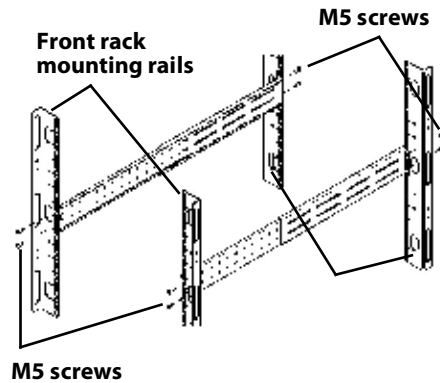

Figure 10: Installing the rear member and front member of each bracket assembly

- Get eight M4 screws and eight M4 nuts from the hardware pack in this kit. Each nut has a locking nylon insert that begins gripping the screw when it is halfway tight. Make sure to tighten the nut and screw completely to ensure locking action. Fasten the rear member and the front member together using four screws and four nuts per bracket assembly as shown in Figure 11. For maximum support, insert fasteners for each bracket assembly as far apart as possible, depending on rack depth, while still joining both members (see Figure 11). Check alignment of bracket assemblies and **TIGHTEN ALL SCREWS** from Steps 2 and 3.

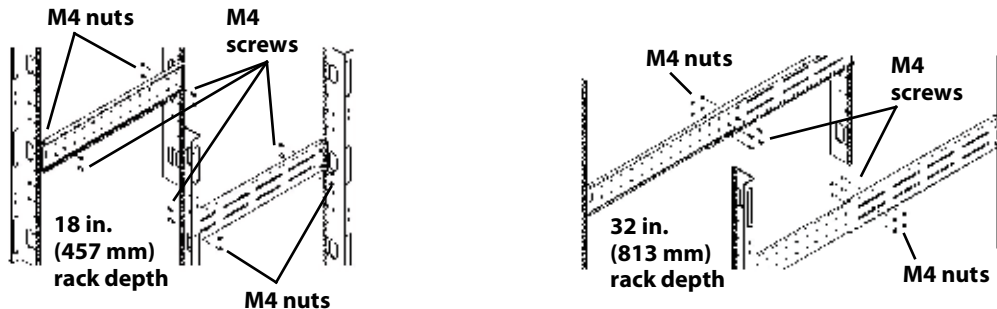

Figure 11: Fastening the rear member and front member together

5. Prepare the UPS or battery cabinet (the “equipment”) for rack mounting. The equipment may require additional parts to be added or removed. After it is prepared, lay the equipment in the rack-mounting position. Fasten the inner members from Step 1 to the equipment on both sides as shown in Figure 12 with eight M4 screws provided in the kit. Make sure the retaining latch is near the rear of the equipment as shown (see Figure 12).

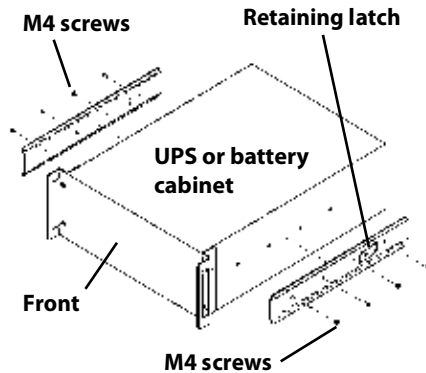

Figure 12: Fastening the inner members

6. If available, apply a bead of grease 25 mm (1 in.) long at four places inside the bottom curved tracks of the front members as shown in Figure 13. The grease will allow the equipment to slide into the bracket assemblies more easily.

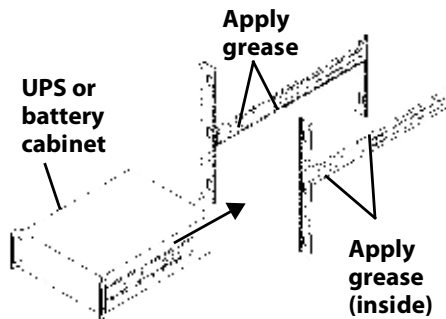
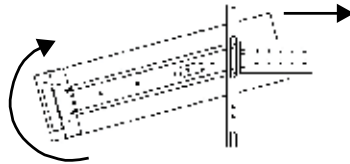

Figure 13: Applying grease

⚠ CAUTION

Lifting equipment into the rack may be a two-person job, depending on the weight of the equipment. SolaHD recommends taking the internal batteries out of the UPS during rack installation. This will make the UPS cabinet lighter and easier to handle. For the weight of the UPS and battery cabinet, see “12.0 Specifications”. Do not use the factory supplied rack handles to lift the UPS; their intended use is to slide the UPS in and out of the rack.

7. Insert the equipment, with inner members attached, into the bracket assemblies by inserting the top and bottom edges of the inner members into the top and bottom curved tracks of the front members. Slide the equipment into the rack (see Figure 14). The ends of the inner members are tapered to allow the rear of the equipment to be angled upward before insertion, if space allows. The equipment should move smoothly into the bracket assemblies. If it does not, recheck the alignment of the front and rear members from Steps 2 and 3.



**Insert the UPS into the front members.
Lift the front and push it into the rack.**

Figure 14: Insert the UPS

8. Secure the front of the equipment to the rack mounting rails to prevent the equipment from sliding out of position. If securing holes are provided on the front of the equipment that align with the center holes on the return flange of the front members, you can use the four extra M5 screws provided in the kit to secure the equipment. Otherwise, the equipment should be secured to the front of the rack with four customer-supplied fasteners.

5.3 External Battery Cabinet Installation

Optional external battery cabinets may be connected to the UPS to provide additional battery backup times. External battery cabinets are designed to be placed on one side of the UPS in a tower configuration or stacked beneath the UPS in a rack configuration.

⚠ CAUTION

The external battery cabinet(s) are heavy (see “12.0 Specifications”). Take proper precautions when lifting them.



Figure 15: Typical external battery cabinet connections

1. Inspect the external battery cabinet for freight damage. Report damage to the carrier and your SolaHD representative.
2. For slide rail installations, first remove the top/side fin. Top/side fin slides forward and then lift up to remove. Optional rack-mount handles are shipped with the external battery cabinet and may be installed at this time if desired.
3. Securing hardware and slide rails are sold separately. Please contact your local dealer or SolaHD representative for these additional options and any assistance needed. Fasten the slides into position with the screws per the instructions included with the slide rail kit.
4. Use the enclosed support bases for the tower option to prevent tip-over. One additional set of support base extensions ships with each external battery cabinet.
5. Put the UPS into Bypass Mode by pressing the Standby/Manual Bypass button one time (hold it for about 2 seconds).
6. Verify the external battery cabinet breaker is in the OFF position.
7. Connect the supplied external battery cabinet cable to the rear of the external battery cabinet, then to the rear of the UPS.
8. Turn the external battery cabinet breaker to the ON position.
9. Press the ON button on the front of the UPS for four seconds to return the unit to Inverter Mode.
10. Verify the circuit breaker on the external battery cabinet is in the ON position.
11. Use the included configuration program to program the UPS for the number of external battery cabinets connected. Instructions for the configuration program are in “6.0 Configuration Program”.
12. The UPS is now equipped with additional battery backup time. Refer to Table 11 for approximate backup times.

NOTE: When removing the external battery cabinet, the circuit breaker on the rear of the cabinet must be turned off before disconnecting the cable.

NOTE: If the UPS is to be shipped or stored for an extended time, the connector should be disconnected. This will minimize any standby current drain on the batteries and help attain their design life.

5.4 Connect Input/Output Power

The UPS should arrive with the power distribution box attached. If the box needs to be removed for maintenance or replacement, follow these instructions to remove and install the power distribution box.

NOTE: Do not operate the UPS with the power distribution box removed. To shut off all power to this box and to the load, the main input power must be disconnected.

To remove the power distribution box:

1. Put the UPS in maintenance bypass by pressing the Standby/Manual Bypass button once (hold it for about 2 seconds) while the UPS is in Mains (AC) Mode. For help, refer to "8.4 Put the UPS in Manual Bypass".
2. Loosen one captive screw over the maintenance bypass breaker (see Figure 16 for the breaker's location).
3. Turn the maintenance bypass breaker on.

NOTE: The load is unprotected from disturbances in the power supply while the UPS is on bypass.
4. Turn the output and input breakers off.
5. Loosen the other captive screws until the power distribution box releases.
6. Remove the power distribution box from the UPS and set it aside.
7. Slide the plastic cover over the power distribution box connector and tighten the screws.

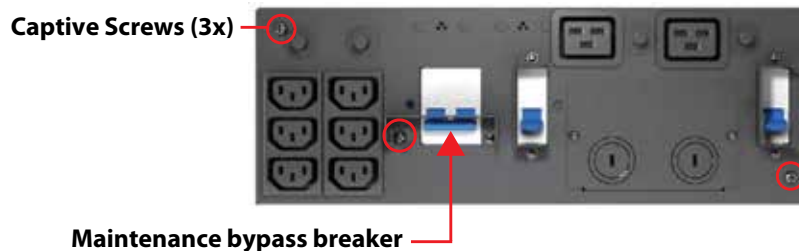

Figure 16: Power distribution box removal

To install the power distribution box:

1. Remove the plastic cover from the power distribution box connector.
2. Align the connectors and press the power distribution box onto the UPS.
3. Hold the box firmly against the UPS and tighten the captive screws, except for the one over the maintenance bypass breaker.
4. Turn the output and input breakers on.
5. Start the UPS according to startup instructions.
6. Verify that the UPS lamp is illuminated.
7. Turn the maintenance bypass breaker off.
8. Insert the maintenance bypass breaker bracket behind the captive screw and tighten the screw.

NOTE: The maintenance bypass breaker bracket must be installed behind the captive screw and the screw must be tightened for the UPS to operate in Inverter Mode.

5.4.1 Power Distribution Box Electrical Connections

Electrical connections are made through the power distribution box (which is attached to the rear of the UPS).

- S4KPAD2-CEHWMBSC fits the S4K5U6K5C.

The installer must provide an upstream branch circuit breaker. The input and output circuit breakers on the power distribution box will disconnect all power between the main cabinet and the power distribution box.

Table 1: Branch Circuit Breaker Ratings	
Model	Maximum Breaker Rating
S4K5U6K5C	D Type 32 A

This UPS is equipped with a manual bypass breaker. It passes bypass power directly to the bypass breaker from the input terminal block. The input circuit breaker on the power distribution box does not disconnect power from the manual bypass breaker.

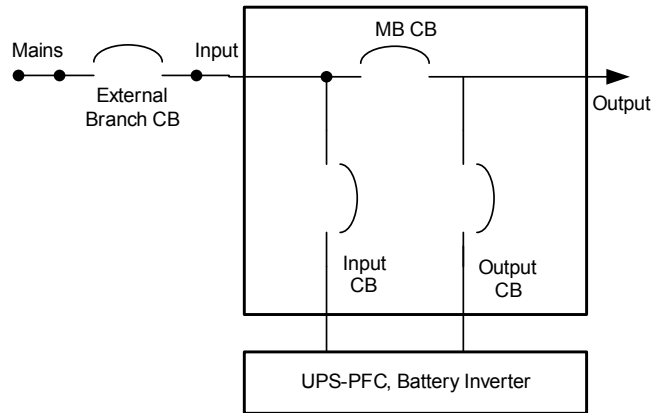

Figure 17: Power distribution box electrical connections diagram

5.4.2 Terminal Block Connections

Conduit entry holes are provided on the rear and side of the box. Input and output wiring should not share the same conduit. SolaHD recommends using strain relief when installing the wire.

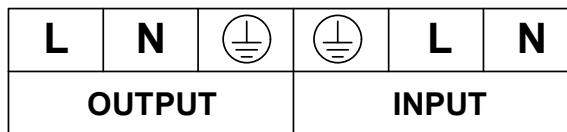

Figure 18: Terminal block connections

Table 2: Electrical Specifications				
Model	Recommended Maximum External Overcurrent Protection	Recommended Wire (including ground wire)	Maximum Wire Accepted by the Terminal Block	Terminal Tightening Torque
S4K5U6K5C	32 A	4 mm ² (10 AWG), 75°C copper	6 mm ² (8 AWG)	2.26 N-m (20 in-lb)

NOTES:

- The installer must provide circuit breaker protection according to local codes. The mains disconnect should be within sight of the UPS or have an appropriate lock-out. Maintain service space around the UPS or use flexible conduit.
- The installer must provide output distribution panels, circuit breaker protection, or emergency disconnects according to local codes. Output circuits must not share a common conduit with any other wiring.

6.0 Configuration Program

The final step of installation may require custom configuration of your UPS using the enclosed configuration program (located on the CD). Some configuration settings may be changed only while the UPS is off. These settings should be set before the UPS is put into service powering critical loads.

For most users operating with 230 VAC and with no external batteries, the factory default settings will be adequate. Programming the output voltage to 200 or 208V results in derating of the unit. Please refer to the nameplate label for power and VA ratings.

6.1 Configuration Program Features

- Select L–N output voltages to match local voltages.
- Enable/Disable Auto-Restart.
- Select frequency converter operation with a fixed output frequency of 50 or 60 Hz.
- Set the Low Battery alarm time to a value of 2 to 30 minutes.
- Enable/Disable the Auto-Battery Test.
- Set the Auto-Battery Test for 7, 14, 21, or 28 days.
- Specify the number of external battery cabinets connected to the UPS to adjust the remaining backup time calculations reported by software products.
- Modify the shutdown setting of the terminal block.

6.1.1 What You Will Need

In addition to the UPS, you will need the configuration program (located on the CD) and USB cable; both are included in the UPS accessory box. A computer running Windows 2000®, XP® or Vista® is required to set up and run the configuration program.

7.0 Controls & Indicators

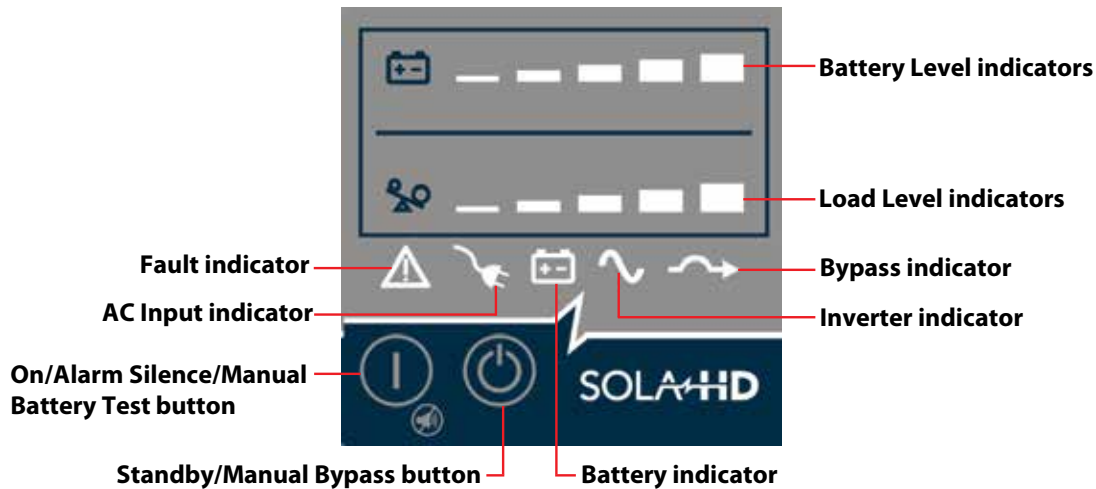

Figure 19: Operation and display panel

7.1 On/Alarm Silence/Manual Battery Test Button

This button controls output power to connected load(s) and has three functions:

- **On:** Pressing this button for 4 seconds will start the UPS.
- **Alarm Silence:** To silence alarms, press this button for at least 1 second. After the alarm is silenced, the UPS will reactivate the alarm system to alert of additional problems.
NOTE: The Low Battery and Bypass reminder alarms CANNOT be silenced.
- **Manual Battery Test:** To initiate a manual battery test, press the On button for at least 1 second while operating from mains power with no alarm conditions present. If only three of the five Battery LEDs illuminate, allow the UPS to recharge the batteries for 24 hours. After 24 hours, retest the batteries.

After the batteries have been retested, if only three of the five Battery LEDs illuminate, contact SolaHD Technical Support at (800) 377-4384 or by e-mail at solahd.technicalservices@emerson.com.

7.2 Standby/Manual Bypass Button

This button controls output power to connected load(s) and has dual functions: Standby and Manual Bypass.

NOTE: Pressing the Standby/Manual Bypass button once will transfer the load to bypass power and the load will be unprotected from disturbances in the mains supply. Pressing the Standby/Manual Bypass button twice within 4 seconds while on bypass will cut off power to the output sockets and connected loads. Perform all necessary shutdown procedures on connected loads before pressing this button twice.

7.3 Load Level Indicators (4 Green, 1 Amber)

The Load Level indicator is composed of five sets of LED bars that illuminate to indicate the relative load on the UPS output in 25% increments (±5%). The load level indicator will illuminate as shown in Figure 20.

The Load Level indicators display the approximate electrical load placed upon the UPS at all times.

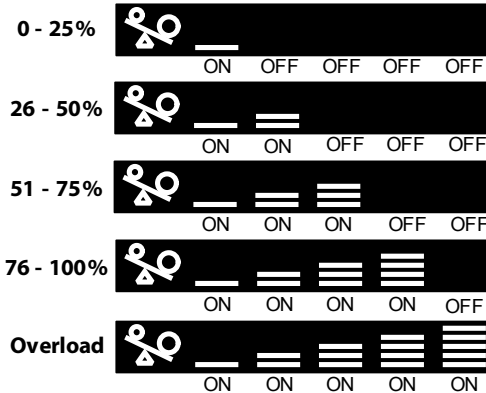

Figure 20: Typical Load Level indicators

7.4 Battery Level Indicators (5 Green)

The Battery Level indicator is composed of five sets of LED bars that illuminate and flash to indicate the battery capacity level. The UPS battery capacity level is shown in 20% increments (±5%). The Battery Level indicators will illuminate as shown in Figure 21. The Battery Level indicators display approximate battery capacity at all times.

The UPS is equipped with automatic and remote battery test features. The default setting is for the automatic test to occur every 14 days (this option is user-configurable) if mains power has not been interrupted. Should the battery fail this test, the red Fault indicator LED along with the A and C Diagnostic LEDs will illuminate and an alarm will sound (refer to “11.0 Troubleshooting”). The remote test feature functions with MultiLink and can remotely initiate the battery test.

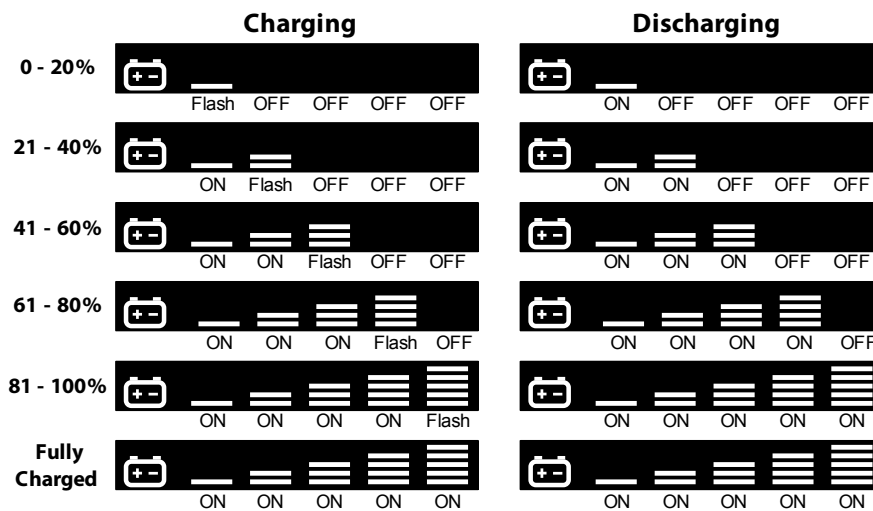







Figure 21: Battery Level indicators

7.5 UPS Status Indicators

UPS status is indicated by five symbols: Fault indicator, AC Input indicator, Battery indicator, Inverter indicator, and Bypass indicator. Table 3 shows the symbols and their meanings.

Table 3: UPS Status Indicators			
UPS Status Indicator	Icon	Color	Description
Fault indicator		Red	On if the UPS has detected a fault; off if there is no fault.
AC Input indicator		Green	On when the mains input power is normal; off during mains failure; flashing when mains power is outside the specifications.
Battery indicator		Amber	On when the battery is supplying power; off when the battery is not supplying power.
Inverter indicator		Green	On when the inverter is supplying power; off when the inverter is not supplying power; flashing when mains power is outside the specifications.
Bypass indicator		Amber	On when the bypass is supplying power; off when the inverter is supplying power; flashing when mains power is outside the specifications.

8.0 Operation

This section describes checks to be made before starting the UPS, how to start the UPS, manual battery test, manual bypass, shutting down the UPS, and disconnecting the mains power from the UPS.

NOTE: The UPS battery is fully charged before delivery, but some charge will be lost during storage and shipping. To ensure that the battery has adequate reserve power to protect the connected load, charge the battery for 3 hours before putting the UPS into service.

8.1 Startup Checklist for the UPS

Before starting the UPS, perform these checks:

1. Check that the input/output cables and loads are connected properly and reliably.
2. Check that all of the battery cables are connected properly.
3. Check that the communication cables are connected properly.

8.2 Initial Startup & Electrical Checks

1. Verify that the input/output circuit breakers are off.
2. During initial system checks, open load disconnects.
3. Inspect all wiring, cables, and connections.
4. If external battery cabinets are used, verify that the battery cables are fully inserted in the sockets.
5. Place the manual bypass breaker in the BYPASS position.
6. Turn on the branch circuit disconnect to apply voltage to the input terminal block.
7. Using a voltmeter, verify the expected L1–N voltage. (Refer to “12.0 Specifications”.) Verify that the same voltages are measured at the output terminals. The Bypass LED (by the switch) will illuminate.
8. After verifying proper input voltage to the UPS terminal block, turn off the branch circuit power, close all access panels to the distribution box and reapply input power.
9. Close the input circuit breaker located on the distribution box. The green AC Input LED should illuminate on the front panel.
10. Press the On button for 4 seconds. After several seconds, the UPS ON LED will illuminate continuously. If the batteries are determined to be charged above 80%, an automatic battery test will run for about 15 seconds.
11. Close the output circuit breaker on the rear of the power distribution box. The light by the input breaker will illuminate.
12. Return the manual bypass breaker to the INVERTER position. The output terminal block will be powered at this time.
13. Connect all loads for normal operation.

8.3 Manual Battery Test

To initiate a manual battery test, press the On/Alarm Silence/Manual Battery Test button for at least half a second while operating from mains power with no alarm conditions present.

- If only the first two of the five LED segments illuminate, allow the UPS to recharge the batteries for 24 hours. Retest the batteries after 24 hours of charging.

After the batteries have been retested, if only two of the five Battery LEDs illuminate, contact SolaHD Technical Support at (800) 377-4384 or by e-mail at solahd.technicalservices@emerson.com.

- If zero of the five Battery LEDs illuminate during a manual battery test, check the battery connection and allow the UPS to recharge the batteries for 1 hour, then initiate a manual battery test again.

If zero of the five Battery LEDs illuminate during the second manual battery test, replace the batteries and contact SolaHD Technical Support at (800) 377-4384 or by e-mail at solahd.technicalservices@emerson.com.

8.4 Put the UPS in Manual Bypass

Press the Standby/Manual Bypass button and hold it for about 2 seconds while the UPS is in Mains (AC) Mode. The UPS will transfer the connected loads to the internal bypass. If the internal bypass is not available because of mains power problems, pressing this button once will be ignored. Bypass operation is indicated by an audible alarm and illuminated amber Bypass indicator.

8.5 Shut Down the UPS

1. Transfer the UPS to manual bypass by pressing the Standby/Manual Bypass button once (hold it for about 2 seconds). If manual bypass is not available, disregard the first step.
2. Press the Standby/Manual Bypass button twice within 4 seconds (hold the button down for about 2 seconds each time) to shut down the UPS.
3. Power to the connected loads is now off.

8.6 Disconnecting Input Power from the UPS

1. After the UPS has been shut down as detailed in "8.5 Shut Down the UPS", turn off the output circuit breaker.
2. Wait 30 seconds and verify that all indicators have turned off and the fan has stopped; this indicates that the power-off is complete.
3. Turn the external battery cabinet breaker switch to the OFF position if the UPS has an external battery cabinet.
4. After powering off the UPS, the UPS ceases output and the load is powered off.

8.7 Maintenance Bypass

Maintenance Bypass Mode is used when maintenance or UPS replacement is required.

To place the unit in Maintenance Bypass Mode:

1. Place the UPS on internal bypass. This may be done by one of the following methods:
 - a. Press the Off button on the front panel one time. (The unit will go into static bypass alarm.)
 - b. Slide the bracket away from the maintenance bypass breaker on the rear of the UPS. This requires loosening the captive screw and sliding the bracket up and away from the maintenance bypass breaker. (The unit will go into static bypass alarm.)
2. Verify that the amber LED (located on the rear of the UPS above the maintenance bypass breaker, labeled “maintenance bypass available”) is illuminated.
3. Move the maintenance bypass breaker on the rear of the UPS to the BYPASS position. This requires loosening the captive screw and sliding the bracket up and away from the maintenance bypass breaker.

⚠ WARNING

Before switching the maintenance bypass breaker, always verify that the amber LED on the rear of the UPS is illuminated. If the maintenance bypass breaker is closed while the UPS is operating on inverter, bypass power will feed back to the inverter. This will trigger the UPS alarm, drop the load, and could potentially damage the inverter.

8.8 IT Power System Configuration

1. Remove the screws on the IT power system access cover as shown in Figure 22.
2. Disconnect the connectors as shown in Figure 22.
3. Reinstall IT power system access cover and screws.

NOTE: When connecting to an “IT” system, the installer must provide a 2-pole upstream circuit breaker. Refer to all local and national codes when installing the upstream breaker.

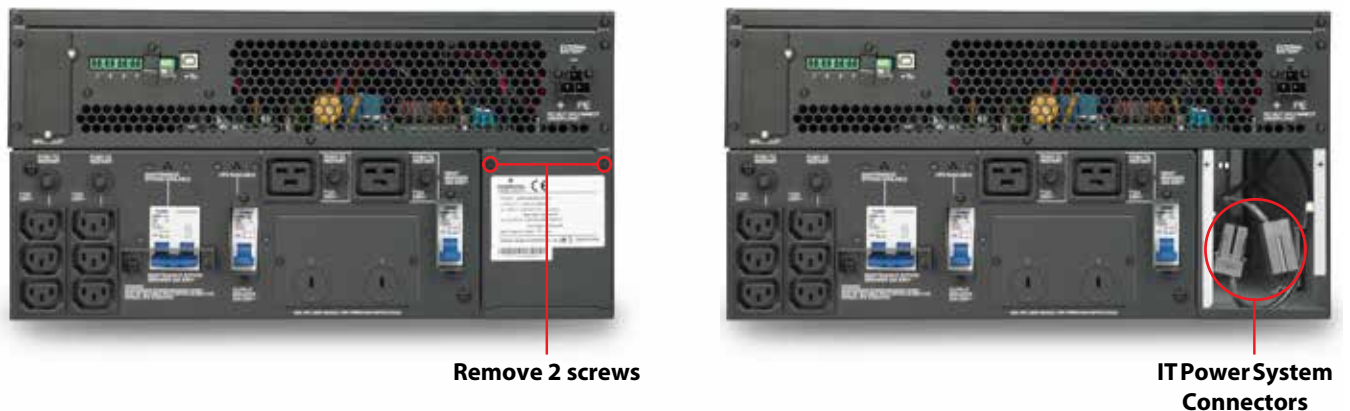

Figure 22: Remove the IT power system access cover

9.0 Communication

9.1 Communication Interface Port

The UPS has a terminal block on the rear of the unit. Several signals are provided on this port and are assigned as follows.

9.2 Terminal Block Communications

The terminal block includes eight PINs, as shown in Figure 23.

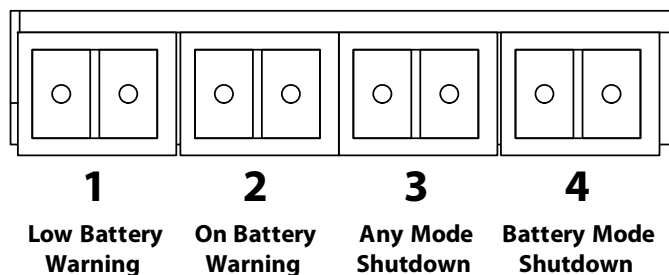

Figure 23: Terminal block communication terminals

9.2.1 Any Mode Shutdown

The purpose of Any Mode Shutdown is to shut down the UPS output by turning off the rectifier, inverter, and static switch so that there is no power to the loads. Activation of the Any Mode Shutdown will be logged as an event in the event history log.

Any Mode Shutdown can be operated locally or remotely:

- **Local** Any Mode Shutdown can be performed by shorting the PINs in Set 3.
- **Remote** Any Mode Shutdown can be performed using a switch connected to the PINs in Set 3 and mounted at a remote location.

NOTES:

- Use the options menu in the configuration program to set the Remote Power Off to either a NO or NC contact at the Any Mode Shutdown PINs.
- The current limited source for the opto coupler (+12 VDC, 50 mA) will be available from the UPS.
- The connection to UPS for remote connection will be via terminal block connector.
- Any Mode Shutdown wiring must conform to all national, regional, and local wiring codes and laws.

⚠ WARNING

When the auto-enable output option is selected and the UPS output is disabled using the PINs in Set 3, the UPS output can turn on automatically and without warning if the Set 3 PIN connection is changed.

9.2.2 Battery Mode Shutdown

Battery Mode Shutdown permits shutting down the UPS by turning off the rectifier, inverter, and static switch so that there is no power to the load when the UPS is On Battery. The auxiliary power for the UPS will still be active. Activation of the Battery Mode Shutdown will be logged as an event in the event history log.

Battery Mode Shutdown can be performed locally or remotely:

- **Local** Battery Mode shutdown can be performed by shorting the PINs in Set 4.
- **Remote** Battery Mode Shutdown can be performed using a switch connected to the PINs in Set 4 and mounted at a remote location.

NOTES:

- The current limited source for the opto coupler (+12 VDC, 50 mA) will be available from the UPS.
- The connection to the UPS for remote connection will be via terminal block connector.
- Battery Mode Shutdown wiring must conform to all national, regional, and local wiring codes and laws.
- The signal must last for 1.5 seconds or longer.
- A Battery Shutdown signal will not cause an immediate shutdown. It will start a 2-minute shutdown timer. This timer cannot be stopped once triggered. If the mains power returns during this countdown, the UPS will still shut down and must remain shut down for 10 seconds. Whether the UPS turns back on when the power is restored depends on the Auto-Restart setting.

9.2.3 On Battery

On Battery signal is a Normally Open (NO) dry contact. When the UPS is supplying output power from the battery this dry contact will be closed.

9.2.4 Low Battery

Low Battery signal is a Normally Open (NO) dry contact. When the UPS is supplying output power from the battery and has reached the Low Battery Warning time selected in the configuration program, this dry contact will be closed.

The dry contact rated values for the On Battery and Low Battery signals are:

- Rated Voltage: 30V (AC or DC)
- Rated Current: 300mA

9.3 UPS IntelliSlot Communication Cards

The IntelliSlot port on the UPS accepts the following optional cards:

- **SNMPWEB Card.** The IntelliSlot SNMPWEB Card provides SNMP monitoring and control of the UPS across the network.
- **IS-RELAY.** The IntelliSlot Relay Card provides dry contact relay outputs for custom-wired applications and delivers support for built-in shutdown for AS/400 systems.

Follow instructions provided with the IntelliSlot card to configure MultiLink, the UPS, or any additional ancillary product for the S4K5U6K5C.

9.3.1 MultiLink

MultiLink continually monitors the UPS and can shut down your computer or server in the event of an extended power failure. It can also be configured for use without the USB cable when the IntelliSlot SNMPWEB Card is installed in the UPS. Additionally, MultiLink can be configured to coordinate shutdown across the network with other computers running MultiLink when you purchase a MultiLink License Kit. For more information about the IntelliSlot SNMPWEB Card and MultiLink License Kits, visit our Web site (www.solahd.com) or contact your SolaHD representative.

9.4 Remote Emergency Power Off

The UPS is equipped with a Remote Emergency Power Off (REPO) connector. The user must supply a means of interfacing with the REPO circuit to allow disconnecting the UPS input feeder breaker to remove all sources of power to the UPS and connected equipment to comply with national and local wiring codes and regulations.

UPS ships with REPO jumper installed allowing the UPS to operate.

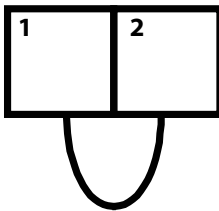

Normally closed switch system (fail-safe)

Opening the REPO connection will disable the UPS. Manual restart using the front panel is required after the REPO connection is closed again.

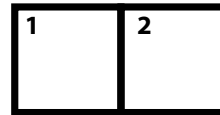

Figure 24: REPO switch connection diagram

⚠ CAUTION

To maintain safety (SELV) barriers and electromagnetic compatibility, signal cables should be shielded and run separately from power cables.

10.0 Maintenance

This section describes replacing the internal battery pack, precautions, checking the UPS status, and checking UPS functions.

10.1 Replacing the Internal Battery Pack

The UPS is designed to allow service personnel to safely replace the internal battery pack. Read the safety cautions before proceeding. Contact your SolaHD representative to obtain the part number of the appropriate replacement battery pack.

10.1.1 Battery Replacement Procedures

1. Gently remove the front metal bezel covers from the UPS.
2. Loosen and remove the six screws on the battery door.
3. Lay the battery door and screws aside for reassembly.

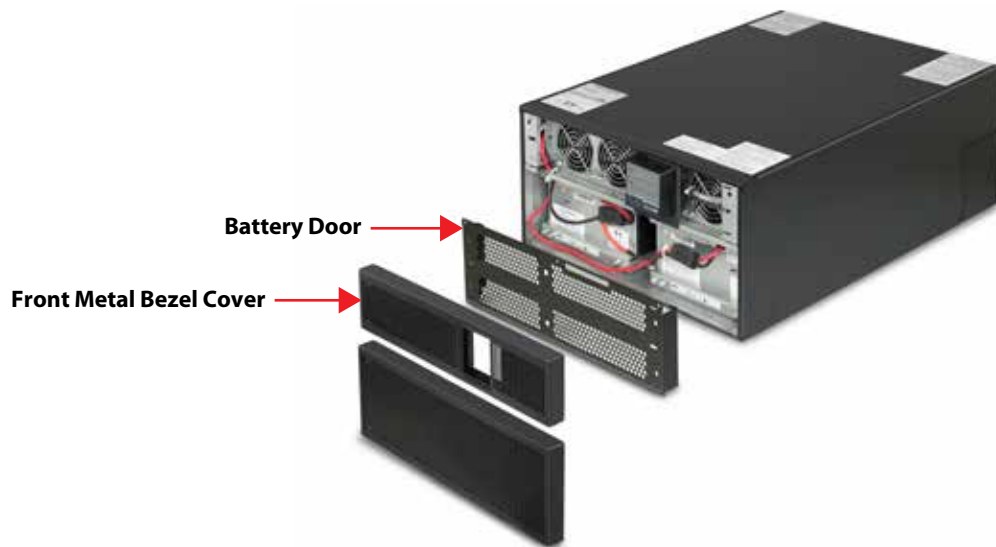

Figure 25: Removing the front metal bezel covers and battery door

4. Gently pull the battery wires out and disconnect the battery connectors and receptacles, as shown in Figure 26.



Figure 26: Disconnecting the battery packs (front view)

5. Grasp the battery handle and pull one of the internal battery packs out of the UPS, as shown in Figure 27. Repeat this step if both battery packs will be replaced. Each model has two battery packs.

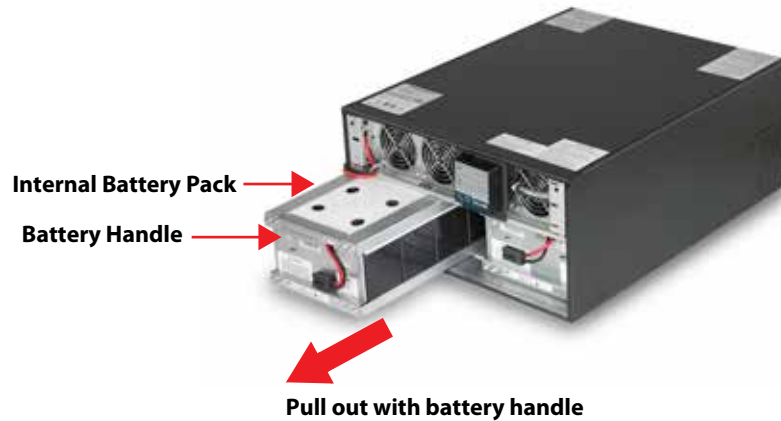

Figure 27: Pulling out the battery packs

6. Unpack a new internal battery pack. Take care not to damage the packaging. Compare the new and old internal battery packs to make sure they are the same type and model. If they are the same, proceed with Step 7; if they are different, stop and contact your SolaHD representative or SolaHD Technical Support immediately.
7. Line up and slide in the new internal battery pack.
8. Repeat Steps 6 and 7 if replacing both battery packs. (This UPS has two battery packs.)
9. Reconnect the battery receptacles and connectors.
10. Gently push the battery wire into the UPS battery compartment.
11. Reattach the front battery door with the six screws.
12. Reattach the front metal bezel covers to the UPS.

NOTE: The internal battery pack is hot-swappable. However, caution should be exercised because the load is unprotected from disturbances and power failures during this procedure. Do not replace the battery while the UPS is operating in Battery Mode. This will result in a loss of output power and will drop the connected load.

10.2 Battery Charging

The batteries are valve-regulated, non-spillable, lead acid and should be kept charged to attain their design life. The UPS charges the batteries continuously when it is connected to the mains input power.

If the UPS will be stored for a long time, SolaHD recommends connecting the UPS to input power for at least 24 hours every four to six months to ensure full recharge of the batteries.

10.3 Precautions

Although the UPS has been designed and manufactured to ensure personal safety, improper use can result in electrical shock or fire. To ensure safety, observe the following precautions:

- Turn off and unplug the UPS before cleaning it.
- Wear rubber gloves, boots, and safety glasses.
- Clean the UPS with a soft, dry cloth. Do not use liquid or aerosol cleaners.
- Never block or insert any objects into the ventilation holes or other openings of the UPS.
- Do not place the UPS power cord where it might be damaged.

10.4 Checking UPS Status

SolaHD recommends checking the UPS operation status every six months.

- Check whether the UPS is faulty. Is the Fault Indicator on? Is the UPS sounding an alarm?
- Check whether the UPS is operating in Bypass Mode. Normally, the UPS operates in Normal Mode. If it is operating in Bypass Mode, stop and contact your local SolaHD representative or SolaHD Technical Support.
- Check whether the battery is discharging. When the mains input is normal, the battery should not discharge. If the UPS is operating in Battery Mode, stop and contact your SolaHD representative or SolaHD Technical Support.

10.5 Checking UPS Functions

NOTE: UPS function check procedures may interrupt power supply to the connected load. Back up the load data before conducting the UPS functions check.

SolaHD recommends checking the UPS functions once every six months.

Procedures are as follows:

1. Press the Standby/Manual Bypass button to check whether the alarm and indicators are normal.
2. Press the On/Alarm Silence/Manual Battery Test button to check again whether the indicators are on and the UPS is operating normally.
3. Press the On/Alarm Silence/Manual Battery Test button for 3 seconds after Inverter Mode. The UPS should initiate a battery self-test. Check to determine whether the battery is operating normally. If not, stop and contact your SolaHD representative or SolaHD Technical Support.

11.0 Troubleshooting

This section indicates various UPS symptoms a user may encounter and troubleshooting steps in the event the UPS develops a problem. Use the following information to determine whether external factors caused the problem and how to remedy the situation.

11.1 UPS Symptoms

The following symptoms indicate the UPS is malfunctioning:

- The relative indicators will illuminate, indicating the UPS detected a problem.
- An alarm will sound, indicating that the UPS requires attention.

11.1.1 Indicators

In addition to the Fault indicator being illuminated, one or more of LED segments of Battery Level indicator will also be illuminated to provide a diagnostic aid to the user, as shown in Figure 28. The descriptions are listed in Table 4.

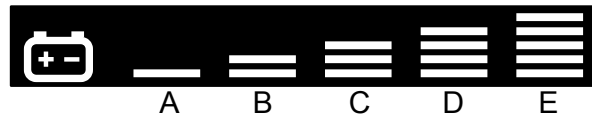

Figure 28: Battery Level indicator

Table 4: Indicator Descriptions		
Indicator	Diagnosis	Audible Alarm
A–E	On bypass from output overload	Half-second beep every half second
A	On bypass due to overtemperature condition	1-second beep every 4 seconds
B	On bypass due to DC bus overvoltage	1-second beep every 4 seconds
C	On bypass due to DC/DC power supply failure	1-second beep every 4 seconds
D	PFC failure	1-second beep every 4 seconds
E	On bypass due to inverter failure	1-second beep every 4 seconds
A & B	UPS failure (includes dual-fan failure, single-fan failure under certain conditions, and battery charger failure)	Continuous alarm
A & C	UPS failed battery test	2-second beep every 60 seconds
A & D	Maintenance bypass switch on	Continuous alarm
A & E	Bypass Feedback	1-second beep every 4 seconds
B & C	REPO	Quarter-second beep every quarter-second
B & E	Short circuit on the output	No audible alarm
C & E	UPS shutdown by command from communication (USB port or IntelliSlot port)	No audible alarm
Battery indicator flashing	Internal battery source not available; check battery connection, power down and reboot the UPS	Continuous alarm
Bypass indicator flashing	Main power voltage or frequency is out of tolerance; bypass is unavailable	No audible alarm

NOTE: A–E indicators are shown in Figure 28.

11.1.2 Audible Alarm

An audible alarm will sound in conjunction with the visual indicators to indicate a change in UPS operating status. The audible alarm will sound as described in Table 5.

Table 5: Audible Alarm Descriptions	
Condition	Alarm
Battery discharge	Half-second beep every 10 seconds
Low battery	Two half-second beeps every 5 seconds
UPS fault, load on bypass	1-second beep every 4 seconds
UPS fault, no power to load	Continuous
Overload	Half-second beep every half second
Battery replacement	2-second beep every 60 seconds
Battery loss	Continuous
Wiring problem (loss of proper grounding for UPS)	Continuous
Bypass reminder	1-second beep every 2 minutes

11.2 Troubleshooting

In the event of an issue with the UPS, refer to Table 6 to determine the cause and solution. If the issue persists, contact SolaHD Technical Support at (800) 377-4384 or by e-mail at solahd.technicalservices@emerson.com.

When reporting an issue to Technical Support, please include the UPS model number and serial number. This information is located on the top panel of the UPS.

Table 6: Troubleshooting		
Problem	Cause	Solution
UPS fails to start when the On/Alarm Silence/Manual Battery Test button is pressed	UPS is short-circuited or overloaded.	Ensure the UPS is off. Disconnect all loads and ensure nothing is lodged in the output receptacles. Ensure loads are not defective or shorted internally.
Battery indicator is illuminated	UPS is not plugged in.	UPS is operating from Battery Mode. Ensure UPS is securely plugged into the wall receptacle.
	UPS input protection fuse has blown/opened.	UPS is operating from Battery Mode. Save data and close applications. Replace UPS input fuse, then restart the UPS.
	Mains power is out of tolerance.	UPS is operating from Battery Mode. Save data and close applications. Ensure mains supply voltage is within acceptable limits for the UPS.
UPS has reduced battery backup time	Batteries are not fully charged.	Keep the UPS plugged in continuously for at least 24 hours to recharge the batteries.
	UPS is overloaded.	Check Load Level indicator and reduce the load on the UPS.
	Batteries may not be able to hold a full charge due to age.	Replace the batteries. Contact your SolaHD representative or SolaHD Technical Support for replacement battery packs.
Fault and Bypass indicators and all LED segments of the Battery Level indicator are illuminated	UPS is overloaded or the load is faulty.	Check the Load Level indicator and remove non-essential loads. Recalculate the load and reduce the number of loads connected to the UPS. Check the load for faults.
Fault and Bypass indicators and Diagnostic A indicator are illuminated	UPS shutdown due to overtemperature condition; load is on bypass power.	Ensure the UPS is not overloaded, ventilation holes are not blocked, or room ambient temperature is not excessive. Wait 30 minutes to allow the UPS to cool, then restart the UPS. If the UPS cannot restart, contact your SolaHD representative or SolaHD Technical Support for assistance.
Fault and Bypass indicators and Diagnostic B indicator are illuminated	UPS internal DC bus overvoltage.	UPS requires service. Contact your SolaHD representative or SolaHD Technical Support for assistance.

Table 6: Troubleshooting		
Problem	Cause	Solution
Fault and Bypass indicators and Diagnostic C indicator are illuminated	UPS DC/DC fault.	UPS requires service. Contact your SolaHD representative or SolaHD Technical Support for assistance.
Fault indicator and Diagnostic D indicator are illuminated	UPS power factor correction circuit fault.	UPS requires service. Contact your SolaHD representative or SolaHD Technical Support for assistance.
Fault and Bypass indicators and Diagnostic E indicator are illuminated	UPS inverter fault.	UPS requires service. Contact SolaHD representative or SolaHD Technical Support for assistance.
Fault indicator and Diagnostic A and C indicators are illuminated	UPS failed the battery test.	Replace the batteries. Contact your SolaHD representative or SolaHD Technical Support for replacement battery packs.
Fault and Bypass indicators and Diagnostic C and E indicator are illuminated	UPS shut down by a command from the communication port(s).	UPS has received a signal or command from the attached computer. If this was inadvertent, ensure the communication cable used is correct for your system. For assistance, contact SolaHD Technical Support.
Fault indicator and Diagnostic A and B indicators are illuminated; continuous alarm sounds	UPS failure (includes dual-fan failure, single-fan failure under certain conditions, and battery charger failure).	Ensure the fan is not blocked up. If the fault is not resolved, contact SolaHD Technical Support for assistance.
Battery indicator is flashing; continuous alarm sounds	Battery source is not available.	Check battery connections, completely power down and restart the UPS. NOTE: If the battery circuit opens while the UPS is running, it will be detected when the next battery test is performed.
Bypass indicator is flashing	The bypass is disabled because the voltage or frequency is outside the acceptable limits.	The AC input powers the PFC input and serves as the bypass source. If AC is present but the voltage or frequency exceeds the acceptable range for safe operation with a load, the bypass will be disabled and this indicator will flash, indicating that the bypass is unavailable.

12.0 Specifications

Table 7: UPS Specifications	
Parameters	Model Number: S4K5U6K5C
Rating	6000 VA/4800 W
DIMENSIONS, W x D x H	
Unit	430 x 574 x 217 mm [16.9 x 22.6 x 8.5 in.]
Shipping	530 x 745 x 516 mm [20.9 x 29.3 x 20.3 in.]
WEIGHT	
Unit	60 kg [132.2 lb]
Shipping	71 kg [156.5 lb]
INPUT AC PARAMETERS	
Nominal Operating Frequency	50 or 60 Hz (Factory default is 50 Hz)
Factory Default VAC	230 VAC
Operating Voltage Range without Battery Operation	176–280 VAC
Maximum Allowable VAC	280 VAC
Input Frequency without Battery Operation	40–70 Hz
Input Power Connection	S4KPAD2-CEHWMBSC Standard (See “3.3 Removable Power Distribution Box”)
OUTPUT AC PARAMETERS	
Factory Default VAC	230 VAC
User-configurable VAC	200/208/220/230/240 VAC (Can be modified using included configuration program)
Output Connections	S4KPAD2-CEHWMBSC Standard (See “3.3 Removable Power Distribution Box”)
Frequency	50 or 60 Hz, nominal
Wave form	Sine wave
Main Mode Overload	>200% for 5 cycles; 151– 200% for 1 second; 131–150% for 10 seconds; 105–130% for 1 minute
BYPASS PROTECTION LIMITS	
Disable Bypass Operation	If input voltage exceeds $\pm 15\%$ of the nominal voltage
Re-enable Bypass Operation	If input voltage returns to within $\pm 10\%$ of nominal output voltage
Disable Bypass Operation	When the input frequency prevents synchronous operation
ENVIRONMENTAL REQUIREMENTS	
Operating Temperature	0°C to +40°C [+32°F to +104°F]
Storage Temperature	-15°C to +50°C [+5°F to +122°F]
Relative Humidity	0% to 95%, non-condensing
Operating Elevation	Up to 1,000 m [3,281 ft.]
Audible Noise	<55 dBA @ 1 m [3.2 ft.] rear; <50 dBA @ 1 m [3.2 ft.] front and sides

Table 7: UPS Specifications	
Parameters	Model Number: S4K5U6K5C
CERTIFICATIONS	
Safety	IEC62040-1:2008 Version
EMI/EMC	IEC/EN/AS 62040-2 2 nd Edition (Cat 2—Table 6)
ESD	EN61000-4-2, Level 4, Criteria A
Radiated Susceptibility	EN61000-4-3, Level 3, Criteria A
Electrical Fast Transient	EN61000-4-4, Level 4, Criteria A
Surge Immunity	EN61000-4-5, Level 3, Criteria A
Transportation	ISTA Procedure 1A

Table 8: Power Distribution Specifications	
Parameters	Model Number: S4KPAD2-CEHWMBSC
Used with UPS Model	S4K5U6K5C
Power Distribution Box Includes:	(2) IEC320 C19 16 A/250 V Sockets (6) C13 10 A/250 V Sockets Manual bypass switch with indicator lamp
Ampere Rating	32 A
Input/Output Power Connections	3-wire hard wired, 6–10 mm ² (8–10 AWG)
User-Supplied Input Branch Circuit Breaker	32 A

Table 9: Internal Battery Specifications	
Parameters	Model Number: S4K240INTBATC
Used with UPS Model	S4K5U6K5C
DIMENSIONS, W x D x H	
Unit	184 x 390 x 113 mm [7.2 x 15.4 x 4.4 in.]
Shipping	262 x 467 x 178 mm [10.3 x 18.4 x 7.0 in.]
WEIGHT	
Unit	20.6 kg [45.1 lb]
Shipping	23.0 kg [50.7 lb]
BATTERY PARAMETERS	
Type	Valve-regulated, non-spillable, lead acid
Qty x V x Rating	20 x 12 V x 9.0 Ah
Battery Mfr./Part Number	CSB HR1221WF2
Backup Time	See Table 11
Recharge Time	3 hours to 90% capacity after full discharge into 100% load
ENVIRONMENTAL REQUIREMENTS	
Operating Temperature	0°C to +40°C [+32°F to +104°F]
Storage Temperature	-15°C to +50°C [+5°F to +122°F]
Relative Humidity	0% to 95%, non-condensing
Operating Elevation	Up to 3,000 m [10,000 ft.]
CERTIFICATIONS	
Safety	IEC62040-1:2008 Version
Transportation	ISTA Procedure 1A

Table 10: External Battery Cabinet Specifications	
Parameters	Model Number: S4K240BATC
Used with UPS Model	S4K5U6K5C
DIMENSIONS, W x D x H	
Unit (with bezel)	430 x 574 x 130 mm [16.9 x 22.6 x 5.1 in.]
Shipping	530 x 745 x 407 mm [20.9 x 29.3 x 16.0 in.]
WEIGHT	
Unit	43.0 kg [94.8 lb]
Shipping	54.0 kg [119.0 lb]
BATTERY PARAMETERS	
Type	Valve-regulated, non-spillable, lead acid
Qty x V	1 x 20 x 12 V
Battery Mfr./Part Number	CSB HR1221WF2
Backup Time	See Table 11
ENVIRONMENTAL REQUIREMENTS	
Operating Temperature	0°C to +40°C [+32°F to +104°F]
Storage Temperature	-15°C to +50°C [+5°F to +122°F]
Relative Humidity	0% to 95%, non-condensing
Operating Elevation	Up to 1,000 m [3,281 ft.]
CERTIFICATIONS	
Safety	IEC62040-1:2008 Version
Transportation	ISTA Procedure 1A

Table 11: Battery Backup Times		
Number of External Batteries/Cabinets	Load % of Capacity	230 VAC RT Models
		6kVA
Internal Battery	10%	97
	20%	47
	30%	33
	40%	22
	50%	17
	60%	14
	70%	11
	80%	9
	90%	8
	100%	6
Internal Battery + 1 External Battery Cabinet	10%	158
	20%	97
	30%	65
	40%	48
	50%	40
	60%	33
	70%	26
	80%	22
	90%	19
	100%	17
Internal Battery + 2 External Battery Cabinets	10%	205
	20%	123
	30%	97
	40%	74
	50%	53
	60%	48
	70%	43
	80%	38
	90%	33
	100%	28
Internal Battery + 3 External Battery Cabinets	10%	223
	20%	158
	30%	110
	40%	97
	50%	78
	60%	66
	70%	52
	80%	48
	90%	44
	100%	41
Internal Battery + 4 External Battery Cabinets	10%	360
	20%	191
	30%	138
	40%	108
	50%	97
	60%	81
	70%	71
	80%	61
	90%	51
	100%	48

Using the configuration program, the user may specify the number of external battery Cabinets attached to the UPS. The factory default is programmed for internal batteries only. Table 11 shows the estimated battery backup times at different loads.

Table 11: Battery Backup Time (continued)		
Number of Batteries/Cabinets	Load % of Capacity	Backup Time (minutes)
Internal Battery + 5 External Battery Cabinet	10%	400
	20%	205
	30%	159
	40%	124
	50%	106
	60%	98
	70%	83
	80%	74
	90%	66
	100%	53
Internal Battery + 6 External Battery Cabinet	10%	420
	20%	215
	30%	186
	40%	144
	50%	112
	60%	105
	70%	98
	80%	90
	90%	77
	100%	70

Note: Run times are based upon new, fully charged standard battery modules and may vary by +/-10%.

12.1 Auto-learning Battery Backup Times

As batteries age, the estimated backup times may become less accurate. The S4K5U6K5C is programmed to “learn” from a full battery discharge and then modify the estimated backup time for the measured battery capacity. This can improve accuracy and compensate for aging batteries or batteries that operate at different ambient temperatures.

The UPS will update the anticipated backup time calculation only under certain conditions:

- The UPS must have a steady load that is greater than 20%.
- The UPS must be at 100% charge at the start of a battery discharge.
- The battery discharge must continue uninterrupted until the batteries reach their end-of-discharge voltage.

If all conditions are not met, the backup time calculation will not be modified.

If the configuration program is used to change the number of battery Cabinets, then the values in Table 11 will be restored. This will override any value that is auto-learned.

13.0 Warranty & Support

13.1 Warranty Information

Please see the “Terms & Conditions of Sale”.

13.2 Technical Support

Phone: (800) 377-4384 or (847) 268-6651

E-mail: solahd.technicalservices@emerson.com

Web site: www.solahd.com

**United States
(Headquarters)**
Appleton Grp LLC
9377 W. Higgins Road
Rosemont, IL 60018
United States
T +1 800 621 1506

Europe
ATX SAS
Espace Industriel Nord
35, rue André Durouchez,
CS 98017
80084 Amiens Cedex 2, France
T +33 3 2254 1390

Canada
EGS Electrical Group Canada Ltd.
99 Union Street
Elmira ON, N3B 3L7
Canada
T +1 888 765 2226

Asia Pacific
EGS Private Ltd.
Block 4008, Ang Mo Kio Ave 10,
#04-16 TechPlace 1,
Singapore 569625
T +65 6556 1100

Latin America
EGS Comercializadora Mexico S
de RL de CV
Calle 10 N°145 Piso 3
Col. San Pedro de los Pinos
Del. Álvaro Obregon
Ciudad de México. 01180
T +52 55 5809 5049

Australia Sales Office
Bayswater, Victoria
T +61 3 9721 0348

China Sales Office
Shanghai
T +86 21 3338 7000

Middle East Sales Office
Dammam, Saudi Arabia
T +966 13 510 3702

Chile Sales Office
Las Condes
T +56 2928 4819

India Sales Office
Chennai
T +91 44 3919 7300

Korea Sales Office
Seoul
T +82 2 3483 1555

SOLAHD

